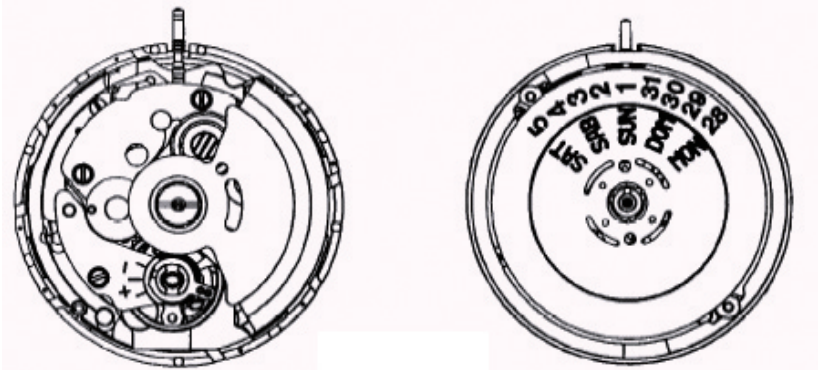
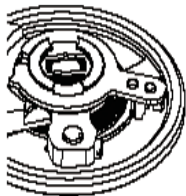
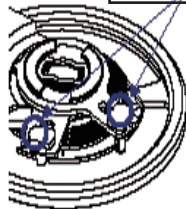

PARTS CATALOGUE/TECHNICAL GUIDE

Cal. 7S26B, 7S36B

[SPECIFICATIONS]

Brand		SEIKO	
Cal. No.		7S26B	7S36B
Item			
Movement		 <p style="text-align: center;">(x 1.5)</p>	
Movement size	Outside diameter	Ø 27.4 mm	
	Casing diameter	Ø 27.0 mm	
	Height	4.9 mm	
Time indication	● 3 hands (hour, minute and second hands)		
Vibration per hour	21,600 Hz/hour (6 beats per second)		
Additional mechanism	<ul style="list-style-type: none"> ● Automatic winding ● Date calendar ● Day calendar ● Date correction function ● Day correction function 		
Jewels	7S26B :21 jewels 7S36B :23 jewels		
The difference between A Cal. and B Cal. * Cal.7S watches are changed from caliber "A" to caliber "B" in October 2006 production. According to the change, we would like you to pay attention to the design of the balance staff when repairing those watches.	7S26A/ 7S36A	7S26B/ 7S36B	
			
	Refer to "PARTS CATALOGUE/ TECHNICAL GUIDE Cal. 7S26A, 7S36A."	Refer to "PARTS CATALOGUE/ TECHNICAL GUIDE Cal. 7S26B, 7S36B."	

SEIKO WATCH CORPORATION



PARTS CATALOGUE

Cal. 7S26B, 7S36B



Disassembling procedures Figs.: ① → ⑤⑩

Reassembling procedures Figs.: ⑤⑩ → ①

Lubricating: Types of oil

-  AO-3 (Moebius A)
-  SEIKO Watch Oil S-6
-  SEIKO Watch Oil S-4

Oil quantity

-  Liberal quantity
-  Normal quantity
-  Small quantity

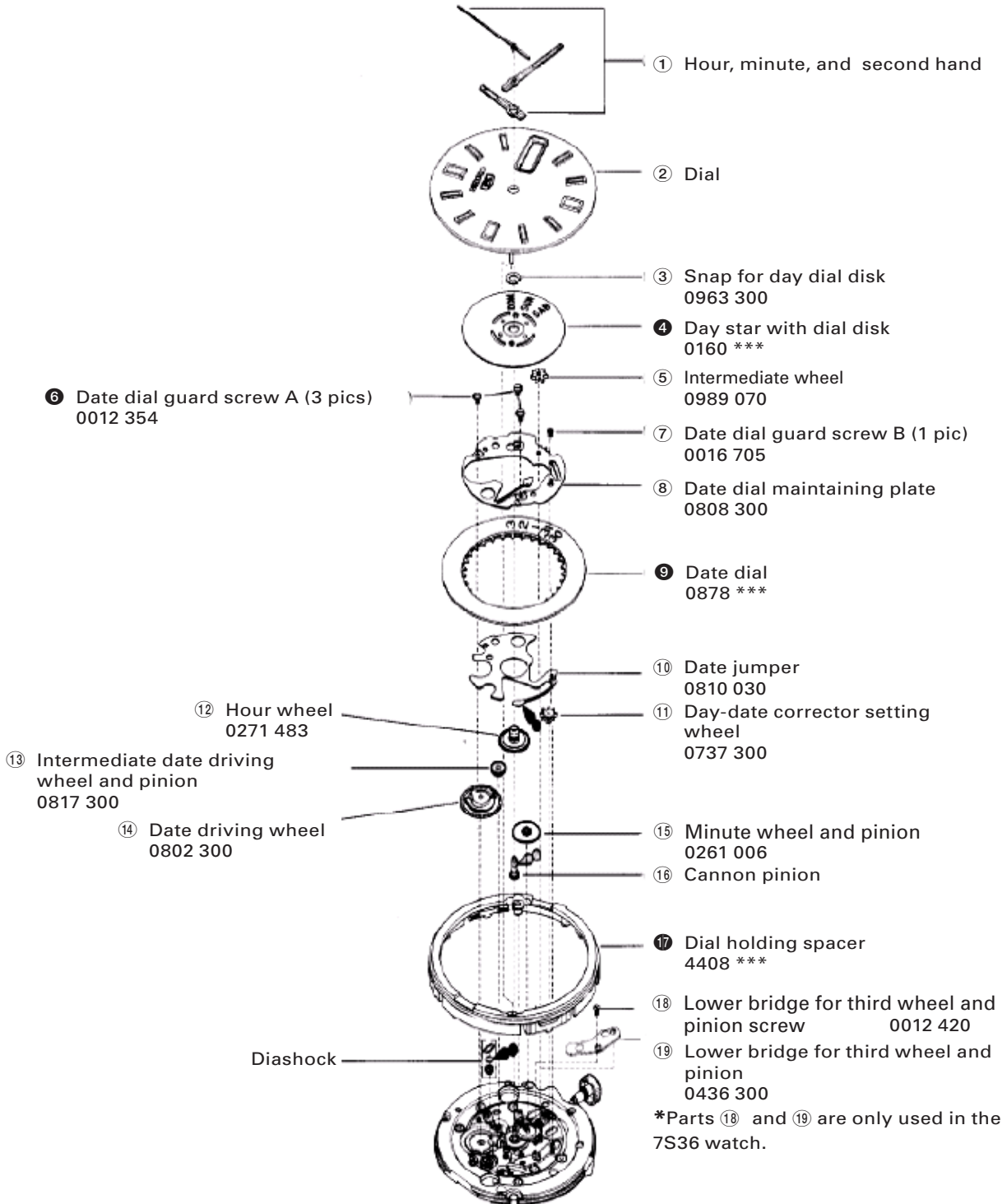

For parts ④, ⑨, and ⑰, refer to "PARTS USED DIFFER DEPENDING ON THE CASING MODEL" on page 5.

PARTS CATALOGUE

Cal. 7S26B, 7S36B

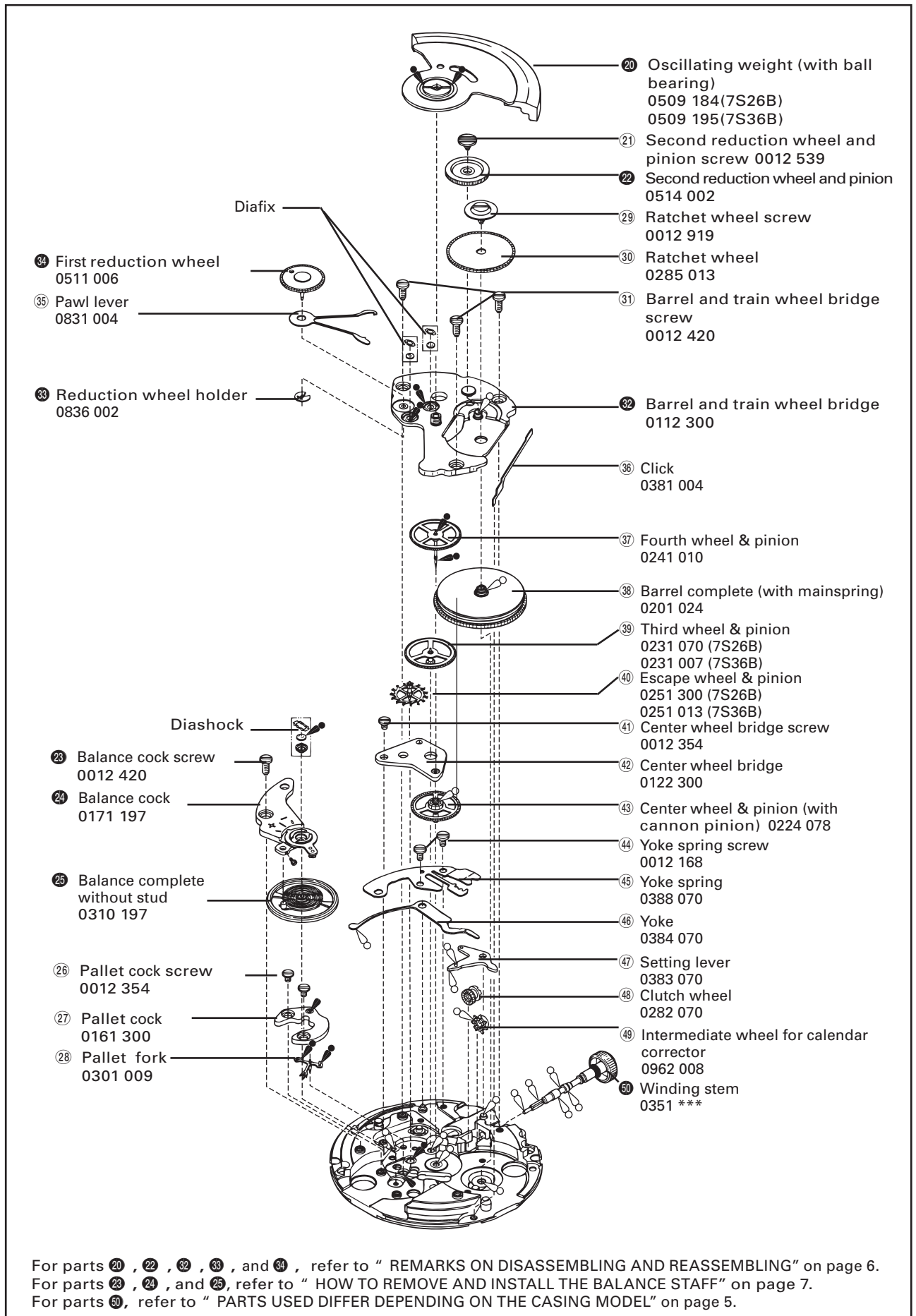





For parts 20, 22, 32, 33, and 34, refer to "REMARKS ON DISASSEMBLING AND REASSEMBLING" on page 6.
 For parts 23, 24, and 25, refer to "HOW TO REMOVE AND INSTALL THE BALANCE STAFF" on page 7.
 For parts 50, refer to "PARTS USED DIFFER DEPENDING ON THE CASING MODEL" on page 5.

PARTS CATALOGUE

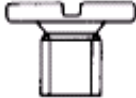
Cal. 7S26B, 7S36B

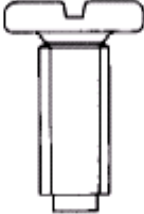
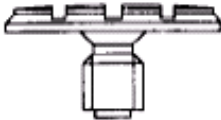
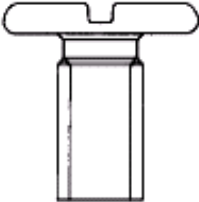
SCREW PARTS

Parts code	Parts name	Parts code	Parts name
	Center wheel bridge screw Pallet cock screw Date dial guard screw A		Ratchet wheel screw
0012 354		0012 919	
	Balance cock screw Barrel and train wheel bridge screw Lower bridge for third wheel and pinion screw		Second reduction wheel and pinion screw
0012 420		0012 539	
	Balance cock screw		Date dial guard screw B
0012 168		0016 705	

Parts name	Parts code	Parts name	Parts code
Upper hole jewel frame for diashock	0014 295	Upper hole jewel frame for third wheel and pinion	0015 701
Lower hole jewel frame for diashock		Upper hole jewel frame for escape wheel and pinion	0015 711
Diashock upper frame	0014 573	Upper spring for third wheel and pin- ion	0015 703
Diashock lower frame	0014 574	Upper spring for escape wheel and pinion	
Diashock upper spring	0014 577	Regulator	0341 020
Diashock lower spring		Stud support	0345 197

PARTS USED DIFFER DEPENDING ON THE CASING MODEL

- ④ Day star with dial disk
0160 ***

- ⑨ Date dial
0878 ***

*The day star with dial disk and date dial used differ depending on the casing model. Refer to the parts code number printed on the day indicator.

- ⑰ Dial holding spacer
4408 ***

The dial holding spacer for a diver's watch has an identifying mark.

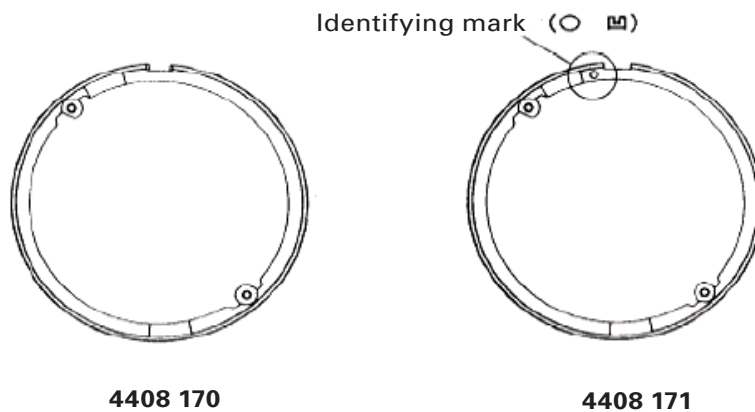

* The dial holding spacer used differs depending on the casing model. Refer to "SEIKO Watch Parts Catalogue (SEIKO WATCH SERVICE SITE)."

- ⑵ Winding stem
0351 ***

* The winding stem used differs depending on the casing model. Refer to "SEIKO Watch Parts Catalogue (SEIKO WATCH SERVICE SITE)."

- The following description is only applicable to 7S caliber watches.

I. REMARKS ON DISASSEMBLING AND REASSEMBLING

20 Oscillating weight (with ball bearing)

The inside screw can be found in the inside ring of the ball bearing. Use the big screwdriver to screw sufficiently tight. When setting the oscillating weight, align the hole of the first reduction wheel with the hole of the balance cock, and then set the oscillating weight by tightening the inside screw of the inside ring of the ball bearing (refer to the right figure).

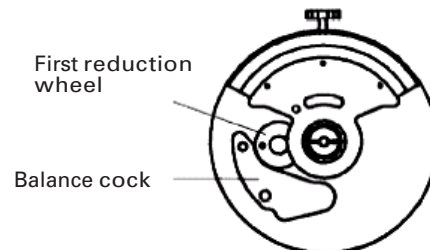

22 Second reduction wheel and pinion

Lubricate the second reduction wheel and pinion (refer to the right figure).

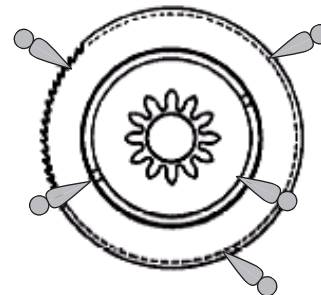

32 Barrel and train wheel bridge

Before setting the barrel and train wheel bridge, set the first reduction wheel, pawl lever, and reduction wheel holder.

33 Reduction wheel holder

How to disassemble

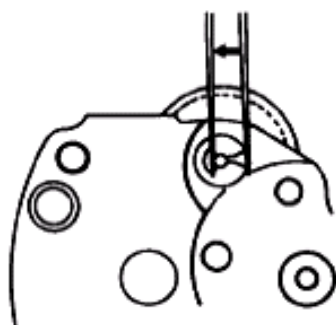

How to assemble

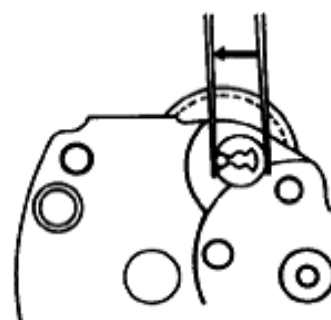

34 First reduction wheel

Liberally lubricate the first reduction wheel. (refer to the right figure)

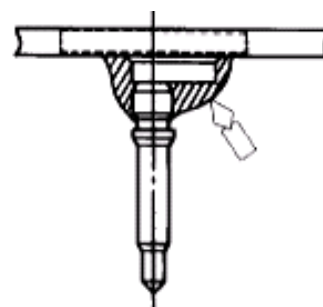

23- 25 : HOW TO REMOVE AND INSTALL THE BALANCE STAFF

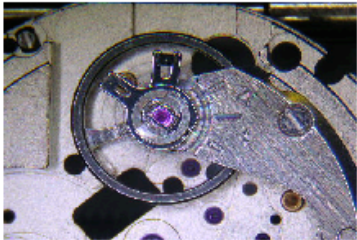
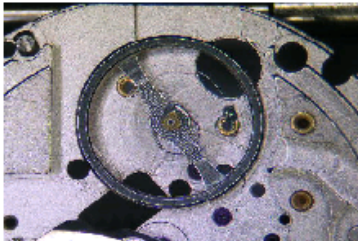
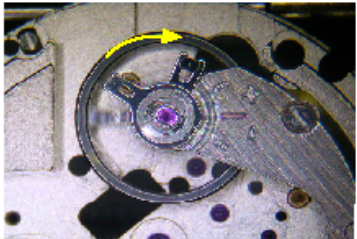
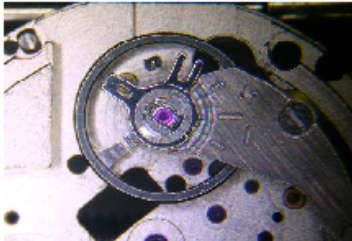
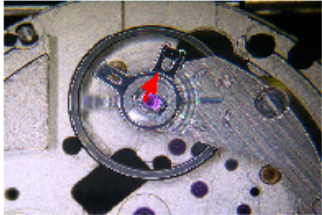
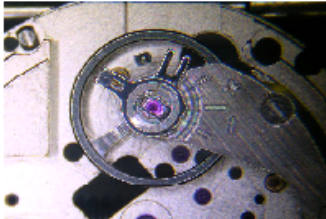
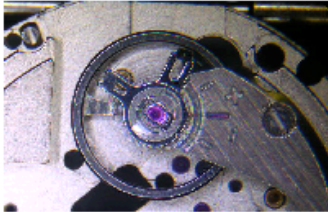
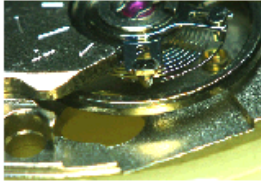
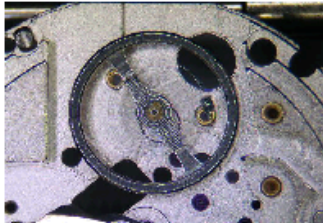
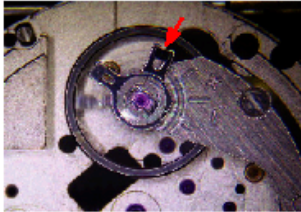
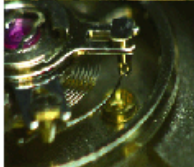
How to remove	How to install
<p>1. Initial phase Set the balance complete with stud and balance cock to the main plate.</p> 	<p>1. Initial phase Set a new balance complete with stud to the main plate.</p> 
<p>2. Move the stud support toward the balance cock until it is attached to the balance cock. * When doing so, make sure that the outer end of the hairspring is not removed from the regulator arm.</p> 	<p>2. Set the balance cock and tighten the balance cock screw.</p> 
<p>3. Using sturdy tweezers, push the stud outward from the direction of the arrow shown in the illustration until it is removed from the stud support.</p>  	<p>3. Temporarily set the stud to the stud support. Make sure that the hairspring passes outside the pin of the regulator arm. * Be careful so as not to damage the hairspring.</p>  
<p>4. Remove the balance cock and replace the balance complete with stud with a new one.</p> 	<p>4. Using sturdy tweezers, set the stud to the stud support and press it down. Make sure that the outer end of the hairspring passes through the regulator slot of the regulator arm. * Be careful so as not to damage the hairspring.</p>  

HOW TO ADJUST THE HAIRSPRING

1. Names of the parts

- A: Stud
- B: Regulator arm
- C: Regulator pin
- D: Stud support

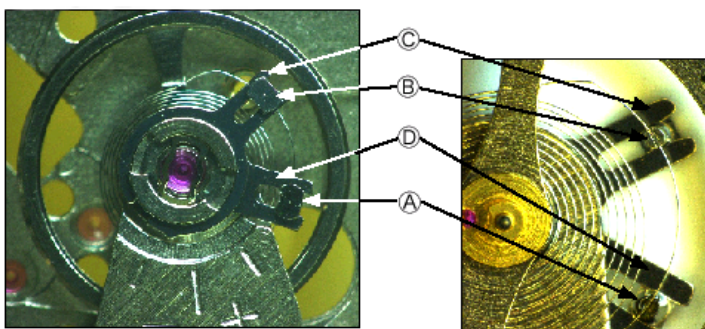

2. Rotate B to fine-tune the position of the outer end of the hairspring which passes through the regulator slot so that the hairspring makes the longest diameter.

3. Rotate A to fine-tune the position of the outer end of the hairspring so that the hairspring passes through the center of the regulator slot.

4. Rotate B to fine-tune the effective length of the hairspring which passes through the regulator slot to define adequate clearance.

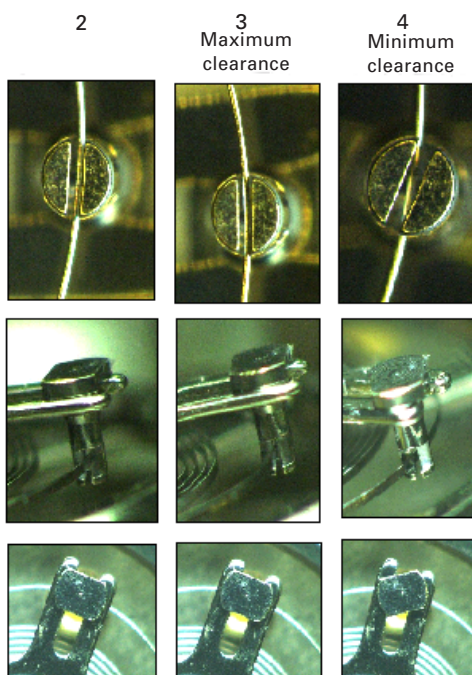

Adjust the position of the hairspring so that it passes through the center of the regulator slot.

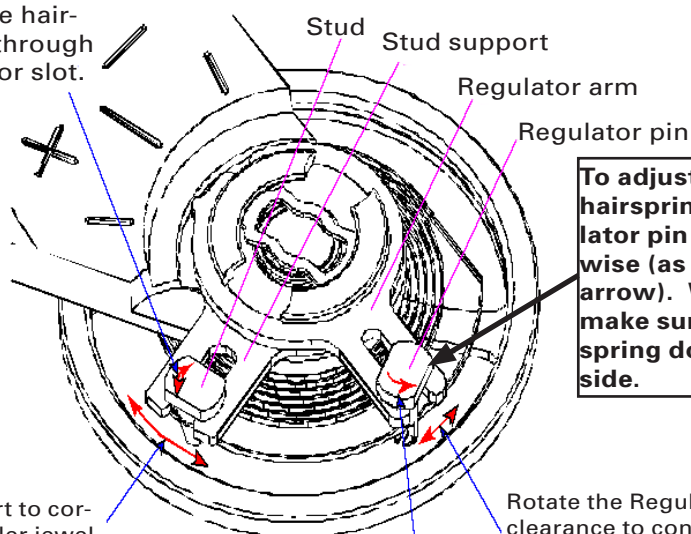

To adjust the length of the hairspring, rotate the regulator pin only counterclockwise (as indicated with the arrow). While doing so, make sure that the hairspring does not lean to one side.

Move the stud support to correctly position the roller jewel.

Adjust the location of the regulator arm to fine-tune the length of the hairspring.

Rotate the Regulator pin to adjust the clearance to control the swing angle of the hairspring.